

## AC、BC Series

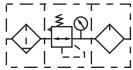

### Symbol



### Product feature

1. The structure is delicate and compact, which is convenient for installation and application.
2. The pressed-in self-locking mechanism can prevent the abnormal movement of the set pressure caused by external interfere.
3. The pressure loss is low and the efficiency of water separating is high.
4. The quantity of oil dripping can be directly observed through transparent check-dome.
5. In addition to standard type, lower pressure type is optional (The highest adjustable pressure is 0.4MPa).

### Specification

Model	AC1500	AC2000	BC2000	BC3000	BC4000
Fluid	Air				
Port size	1/8"	1/4"	1/4"	3/8"	1/2"
Filtering grade	40 μm or 5 μm				
Pressure range	Semi-auto and automatic drain:0.15~0.9MPa(20~130Psi)		Manual drain:0.05~0.9MPa(7~130Psi)		
Max. pressure	1.0MPa(145Psi)				
Proof pressure	1.5MPa(215Psi)				
Temperature range	-5~70°C				
Capacity of drain bowl	15CC		60CC		90CC
Capacity of oil bowl	25CC		90CC		
Recommended	ISO VG 32 or equivalent				
Weight	700g		900g		
Constitute	Filter	AF1500	AF2000	BF2000	BF3000
	Regulator	AR1500	AR2000	BR2000	BR3000
	Lubricator	AL1500	AL2000	BL2000	BL3000

① PT thread, NPT thread and G thread are available.

### Ordering code

AC 2000 M □ □ 1 W □

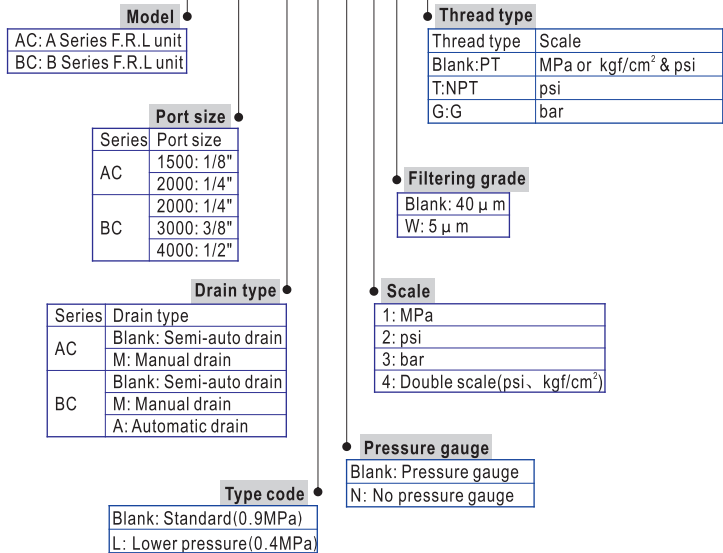

### Pressure and feature of flow

#### Pressure chart

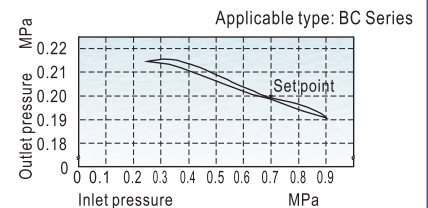
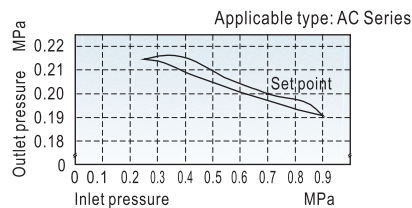

#### Flow chart

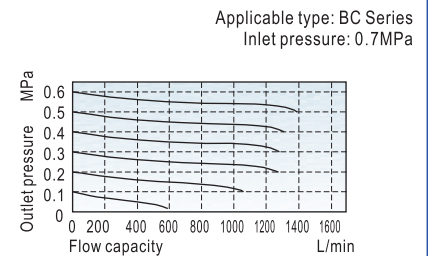
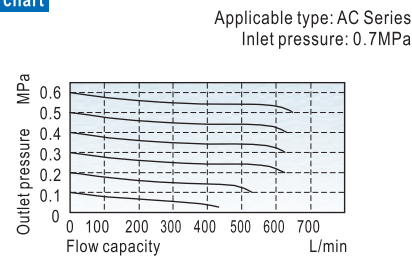

# Preparation unit—F.R.L. combination

## AC、BC Series

### Inner structure

#### AC

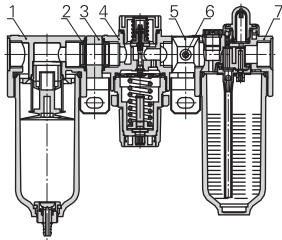

#### BC

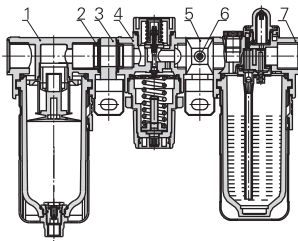

No.	Item	No.	Item
1	AF, BF Series filter	5	A, B Series fix kit
2	A, B Series gasket	6	Screw
3	A, B Series bracket	7	AL, BL Series lubricator
4	AR, BR Series regulator		

### Selection of drain mode

A1500, 2000 Series		B2000, 3000, 4000 Series		
Manual drain	Semi-auto drain	Manual drain	Semi-auto drain	Automatic drain
	<p>This semi-auto drain can also achieve the function of manual drain</p> <p>Φ5</p>			
	<p>PU tube with an inner diameter of Φ4mm is recommended</p>			



AC  
BC

### Dimensions

#### AC

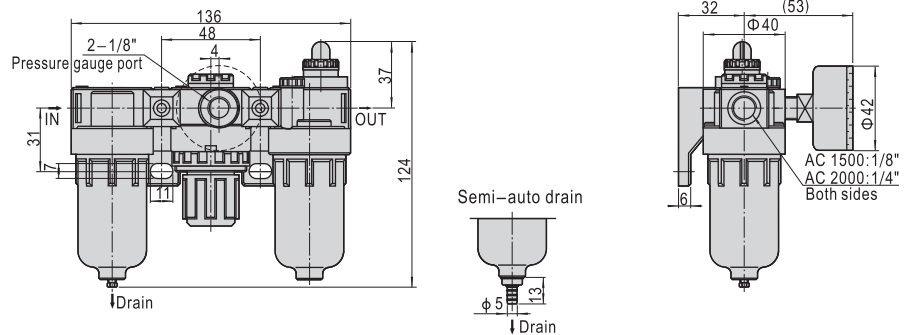

#### BC

